

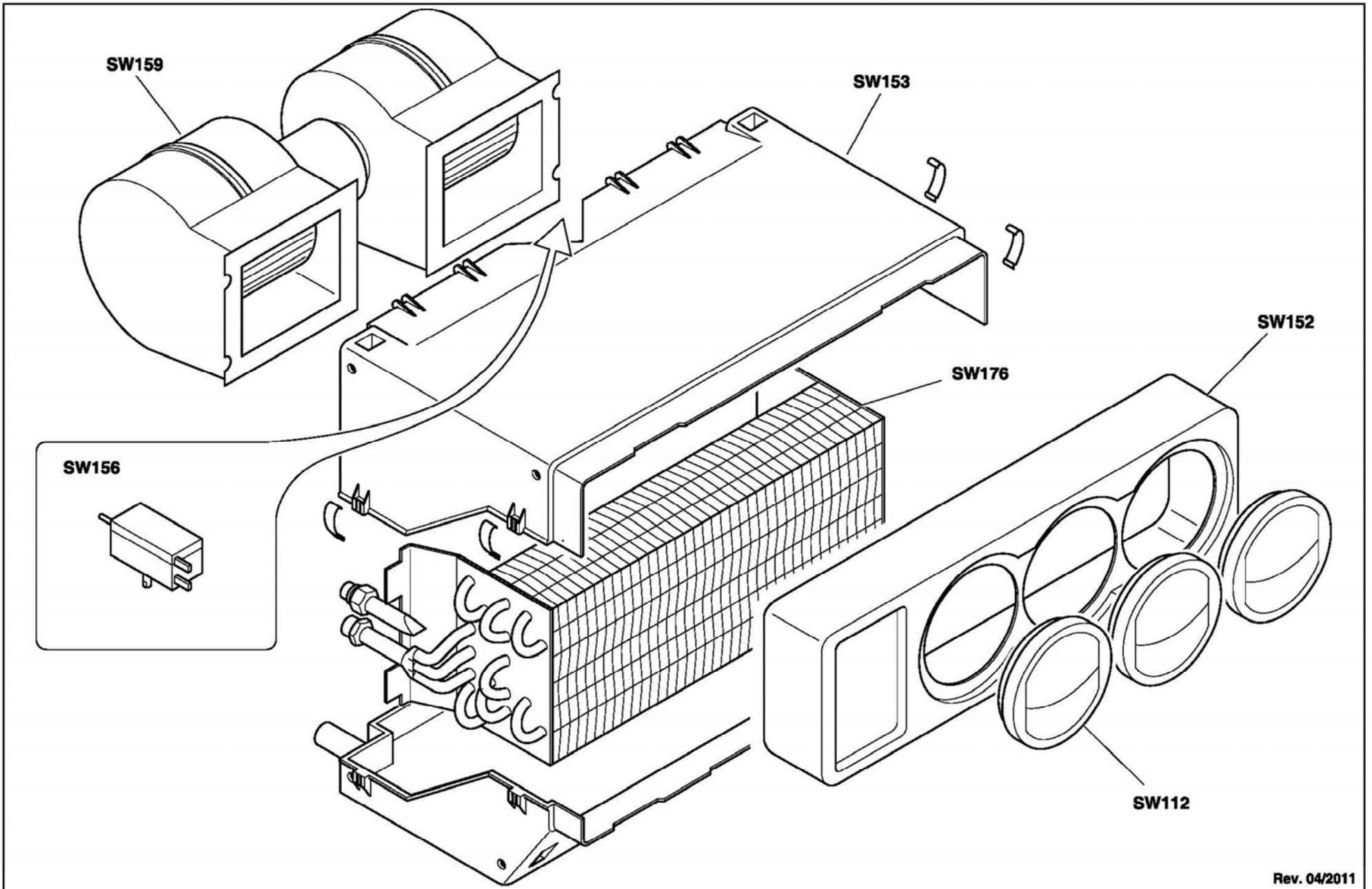

Service Parts Breakdown



Rev. 04/2011

SLEEPING WELL ARCTIC PLUS 12V - SW251 - EVAPORATING UNIT

SPARE PARTS

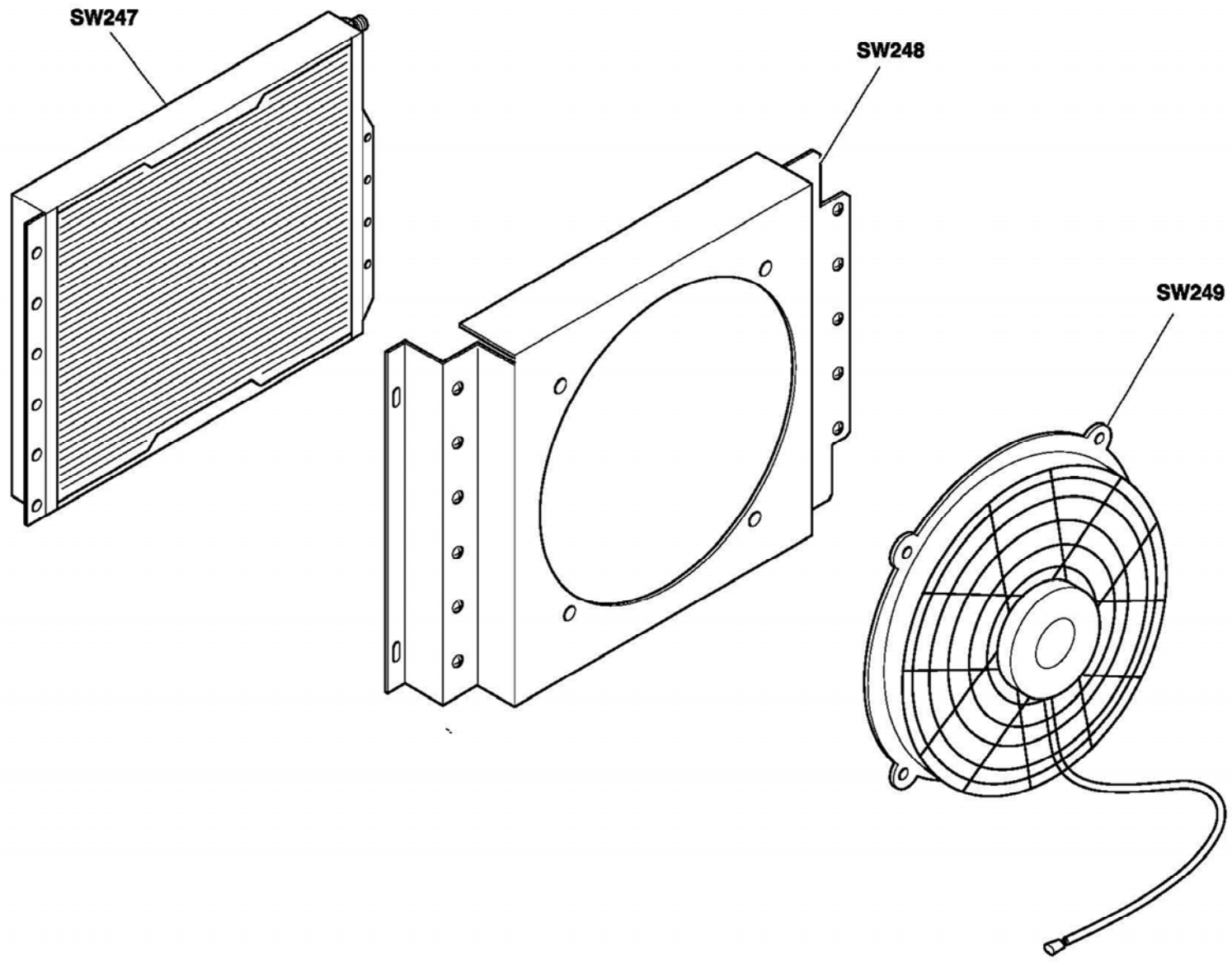

SLEEPING WELL ARCTIC PLUS 12V - SW250 - CONDENSER UNIT

SPARE PARTS



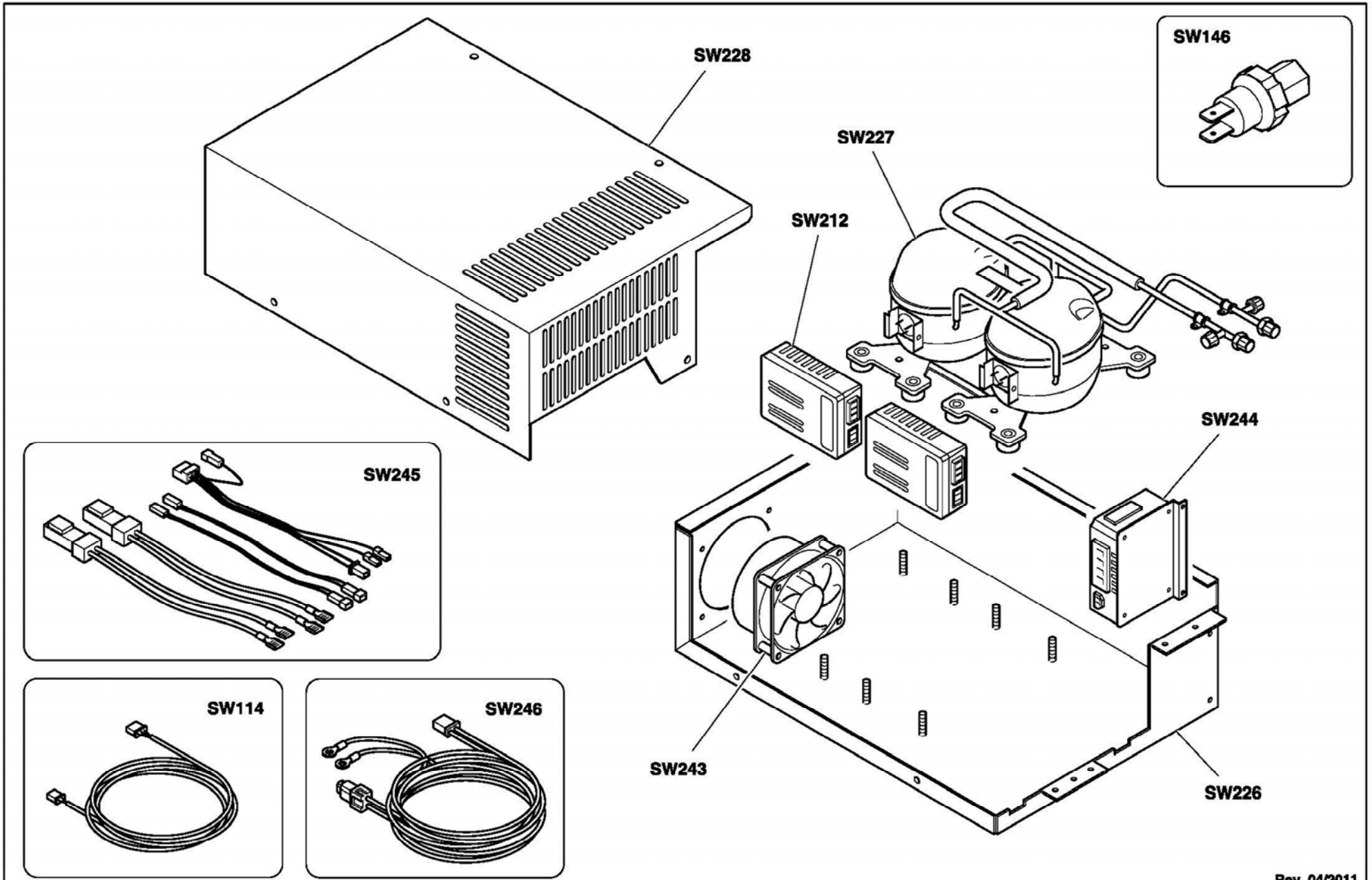





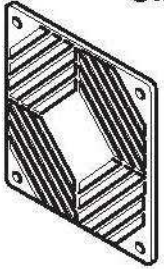

Rev. 04/2011

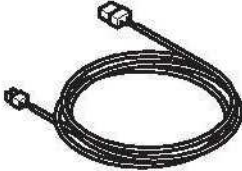
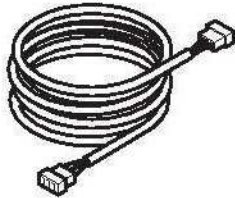
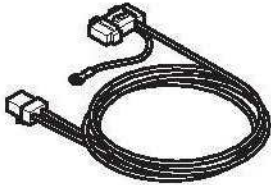
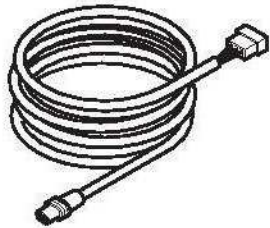

SLEEPING WELL ARCTIC PLUS 12V - SW252 - COMPRESSOR UNIT

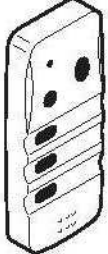
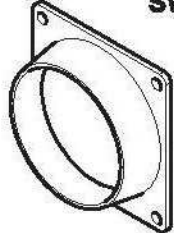
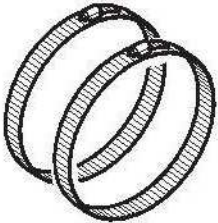
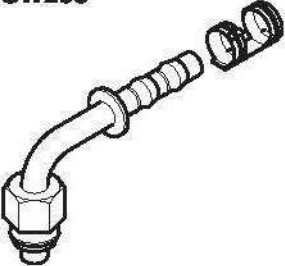
SPARE PARTS

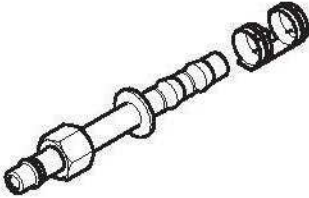
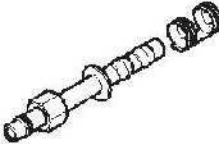
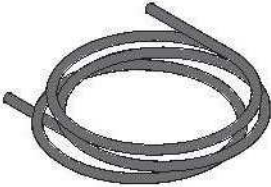
Rev. 04/2011

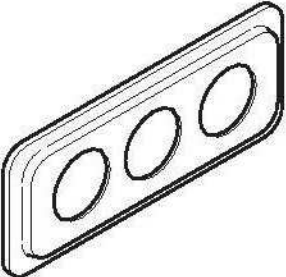
<p>SW242</p> 	<p>SW230</p>  <p>SW229</p>	<p>SW231</p> 	<p>SW232</p> 	<p>SW233</p> 	<p>SW234</p> 
<p>SW236</p> 	<p>SW237</p> 	<p>SW238</p> 	<p>SW239</p> 	<p>SW240</p> 	<p>SW241</p> 
<p>SW253</p> 	<p>SW257</p> 	<p>SW254</p> 	<p>SW256</p> 	<p>SW255</p> 	<p>SW168</p> 
<p>SW166</p> 	<p>SW167</p> 	<p>SW235</p> 			

Rev. 04/2011

Parts Breakdown

Part Number	Description
SW112	Air Vent
SW114	Comm Cable between Splitter and Condenser Unit
SW146	Manostat
SW152	Diffuser Plastic Cover
SW153	Evaporator Plastic Cover
SW156	Anti-Icing Thermostat
SW159	Fan
SW166 – Use 78R8456	G6 Pipe (MT) – 13' 1 ½" (4m)
SW167 – Use 78R8458	G8 Pipe (MT) – 22' 11 ½" (7m)
SW168	Insulation Gasket (MT) – 2 pcs 6' 6 ¾" (2m)/ea = Total 13' 1 ½" (4m)
SW169	Air Grid
SW175	Mounting Set
SW176	Evaporator
SW212	Compressor Module 12v BD 350 GH
SW226	Compressor Assembly Complete Board New SW 2000 Arctic
SW227	BD350GH 12V 102Z3018 - Twin Compressor with Hoses
SW228	Compressor Assembly Complete Closing Carter
SW229	PCB for AC IndelB NA
SW230	Front Control Panel with Label - SW 2000 Arctic
SW231	Probe Connection Cable L=3000 SW 2000 Arctic Plus
SW232	Evaporator Connection Cable L=5 MT New
SW233	Power Supply Cable L=5 MT 10 MMQ
SW234	Condenser Power Supply Cable L=5 MT
SW235	SW 2000 Arctic Evaporator Unit Plastic Frame
SW236	Capillary Pipe with Filter New SW 2000 Arctic – 9' 10" (3m)
SW237	Flexible Ventilation Pipe IMECGH00011AA
SW238	Iron Grid Fan 120x120 MOD. 120
SW239	Remote Control SW 2000 Arctic Version 2011
SW240	Condenser Plastic Conveyor SW 2000 Arctic
SW241	Metallic Plastic Tie IMECDD0038AA
SW242	Black Plastic G120 Grid
SW243	Fan D12A04SWSZ00 12V 6.3x0.8
SW244	Re-Programmed Application Module with Clamp
SW245	Compressor Assembly Internal Cable New SW 2000 Arctic
SW246	Power Supply Cable L=5 MT 4 MMQ
SW247	Battery Condenser Parallel Flow New SW 2000 Arctic
SW248	Complete Conveyor New SW 2000 Arctic
SW249	Axial Fan D305 with Superseal Connector
SW250	Condensing Unit New SW 2000 Arctic
SW251	Evaporator Unit New SW 2000 Arctic
SW252	Compressor Unit New SW 2000 Arctic
SW253 – Use 70R8796	Ftg AOC FOR 90° 8H 6F
SW254 – Use 70R8696	Ftg AOC FOR 90° 6H 6F
SW255 – Use 70R8606	Ftg AOC FOR STR 6H 6F
SW256 – Use 70R8608	Ftg AOC FOR STR 8H 8F
SW257 – Use 70R8698	Ftg AOC FOR 90° 8H 8F